

AIDMICS
BIOTECHNOLOGY

 iSperm

User Manual

Version 5.3

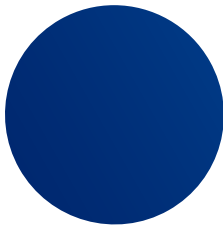

Index

01 Hardware	03
Specification	04
Component	05
Installation (iSperm App, Optical Lens, Sample Collector, Heater)	07 - 16
Latex Beads Test	17 - 20
02 Sampling	21
Basic Principle	22 - 27
Pipette Method	28 - 29
Dropper Method	30 - 31
Dipping Method	32 - 33
03 Software	34
Semen Analysis	35 - 40
Semen Packaging (Equine)	41 - 42
Semen Packaging (Bovine, Canine, Caprine, Swine, Ovine, Murine)	43 - 44
Data Center	45 - 51
Information/Settings	52 - 53
04 Data Backup	54
iSperm Cloud	55 - 56
iCloud	57 - 58
05 Data Transfer	59
Export Videos to Photo App	60 - 63
Transfer Data from iPad	64 - 68
06 Frequently Asked Questions	69 - 75
07 Validation	76 - 81
08 Certificate	82 - 85

01

Hardware

Specifications

Hardware

1. Optical magnification: equivalent to 200x in a traditional microscope.
2. Optical resolution: 1-1.5 μ m.
3. Heater: 37 \pm 0.5°C.
4. Weight: 350g (excluding the Apple iPad mini).
5. Power and battery: LR44 x 3, up to 45 hours.
6. Color: black.
7. Camera specs for iPad mini5.
 - 8MP photos.
 - 1080p/30 Fps Full HD recording.
 - 720p/120 Fps HD recording.

Software

Range of Analysis:

1. Concentration:



2. Motility :
0%-100% for any concentration (**optimized at 30-60 million/ml**).
 3. Progressive motility:
0%-100% between concentration 10-75 million/ml
(**optimized at 30-60 million/ml**).
- Analysis Time: Concentration & Motility <20sec;
Progressive Motility ~30sec.

Semen Sample

1. Fresh semen:
 - Direct measurement of raw semen for quick screening.
 - **Clear/Purified** extender (at 36-37°C) for diluted semen.
2. Thawed semen:
 - **Clear/Purified** extender (at 36-37°C) for frozen-thawed semen.

Product Components



- 1 iSperm Briefcase
- 2 Sample Collector
- 3 Heater and Heater Cable
- 4 Hex Wrench
- 5 Sample Chips (Base & Cover)
- 6 Droppers
- 7 User Manual
- 8 Serial Number Card
- 9 iPad mini and iPad mini Case
- 10 Measuring Cups
- 11 LR44 Batteries
- 12 iPad Stand
- 13 Air Blower
- 14 Bag Strap

Sampling Chips

500 Tests per box; 50 Sets per bag.



Install iSperm App – 1/3

Search and **DOWNLOAD** “iSperm” on App Store.

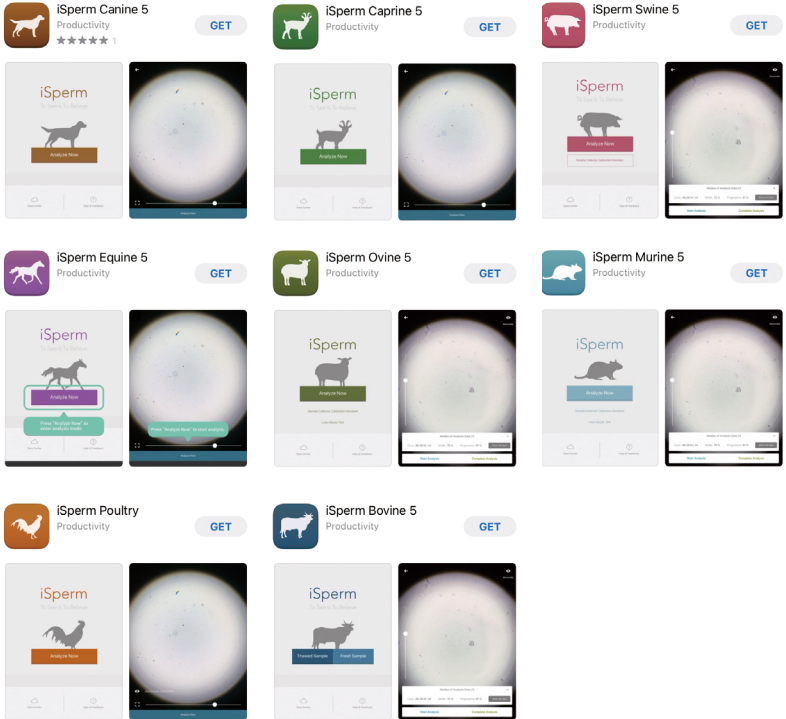

Install iSperm App – 2/3

Open iSperm App. Follow the steps to **ACTIVATE** the App.

Step 1/4

Welcome

For better product support, iSperm provides you an online registration service. There is a unique serial number on each product package. After registration, the product will be covered by an one-year warranty, from the date of purchase.

Internet connection is required during registration. Please make sure the connection is stable.

Next

← Step 2/4

Serial Number

Find the product sticker on the package, and scratch off the silver paint. Then fill in the 12-digit serial number.



**** - **** - ****

Submit

I don't have a Serial Number

← Step 3/4

Warranty Information

Product Owner

Country

Distributor

Submit

Step 4/4

Success

Your product is now activated. The warranty will end on:

(One year after date of purchase)

A serial number can only activate one device. Please keep the serial number in a safe place, and do not share with anyone.

ADQ2-*****

Thank you for your purchase. If you have any question, please contact us at tech.support@aidmics.com

OK

Install iSperm App – 3/3

CREATE A NEW ACCOUNT for iSperm Cloud.

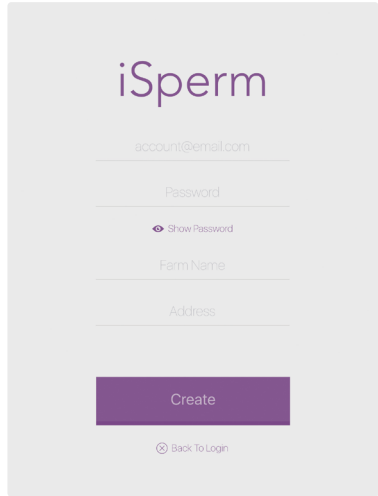
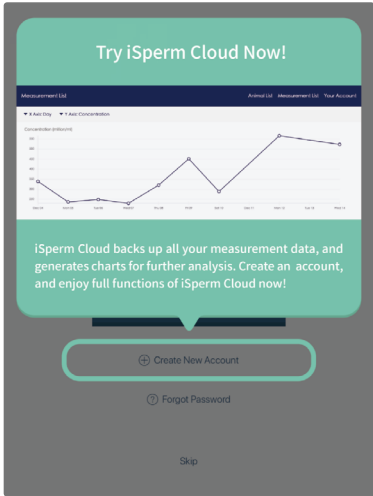

Install iSperm Case with Optical Lens

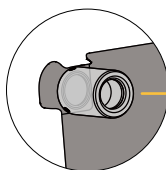

Optical Lens

Insert the top right (where LENS is located) then the bottom right corners into the case.



Press the other two corners of the iPad into the case.

**Reverse the order when removing the case.
This prevents case from being broken at the corner of the lens.**

Use of Sample Collector

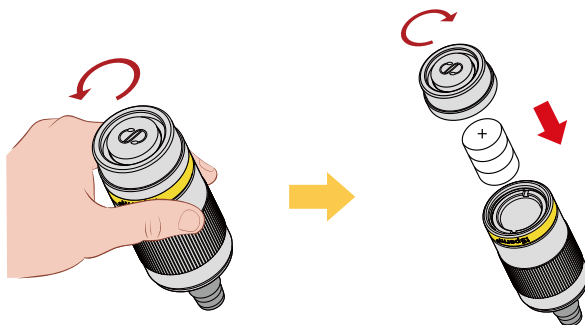

Press the silver ring and screw the end cap counterclockwise, and insert three new LR44 batteries with **anode (+) facing up**. Screw back the end cap clockwise.

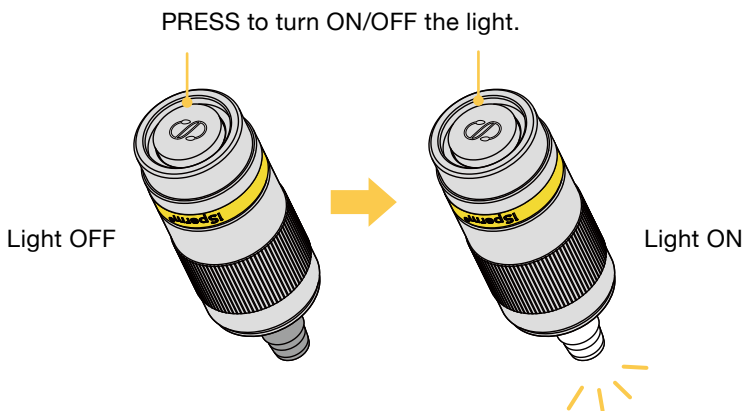

If you see the light is flashing instead of continuously on, please change the batteries.

Optical Alignment – 1/4

Adjustment of 3-axis lens holder for optical alignment is necessary for accurate measurement.

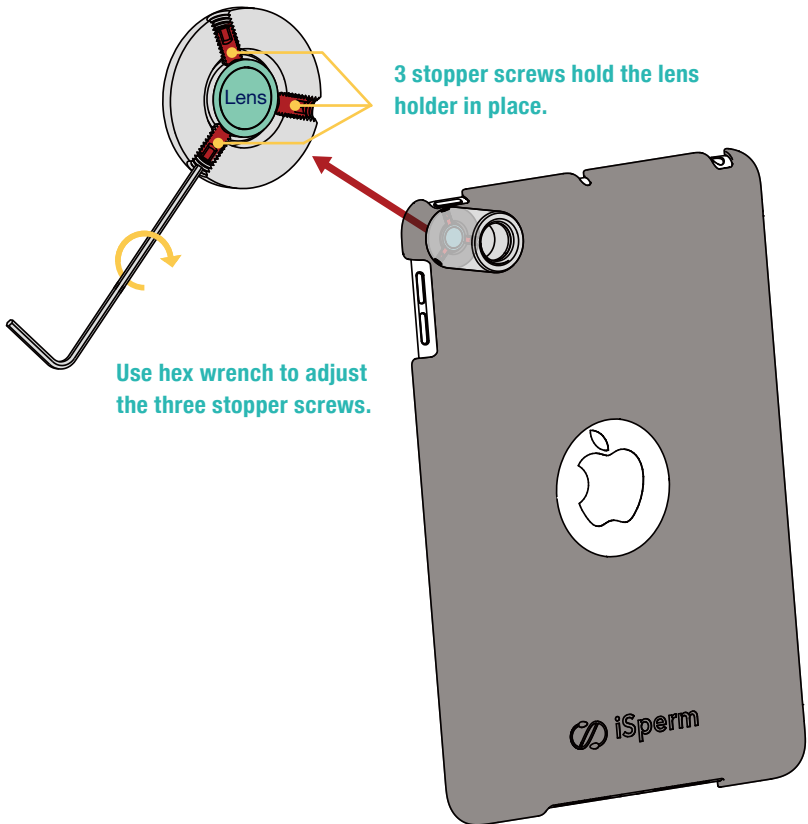

Optical Alignment – 2/4

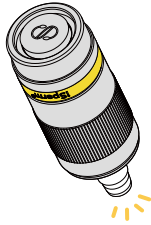

Turn on the light of Sample Collector.

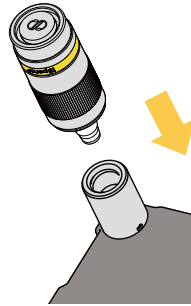

Screw the Sample Collector into the optical lens.

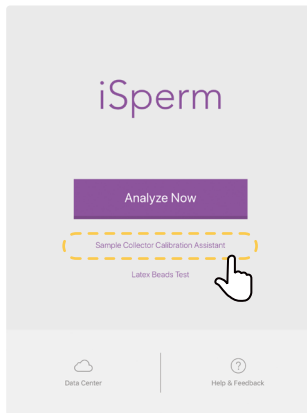

Open iSperm App and tap “Sample Collector Calibration Assistant”.

Users are suggested to execute calibration before the first analysis.

Optical Alignment – 3/4

Decentered lens

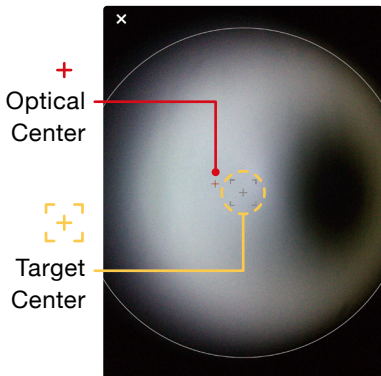

Adjust the Optical Center + to the Target Center [] .

Calibrated

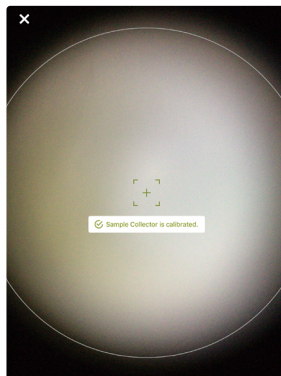

“Sample Collector is calibrated” shows up if the Optical Center is moved to the Target Center.

Decentered Lens Detected

Decentered lens can lead to inaccurate analysis. Please adjust the lens to the center immediately.

Ignore

Adjust Now

Once entering the analyzing mode, decentered lens will cause a warning message.

Optical Alignment – 4/4

CAUTION: Use hex wrench gently

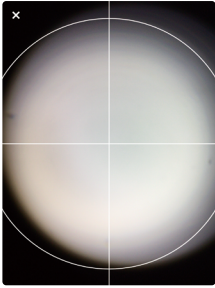

Adjustment example 1:

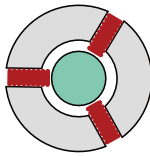

Original

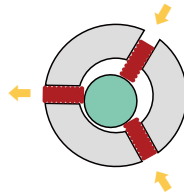

Alignment approach

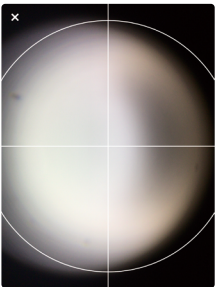

Adjustment example 2:

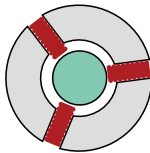

Original

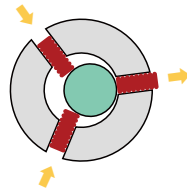

Alignment approach

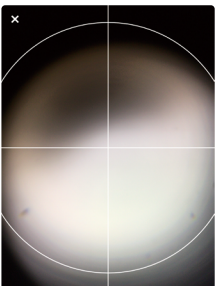

Adjustment example 3:

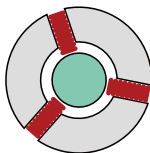

Original

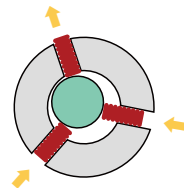

Alignment approach

Heater Installation

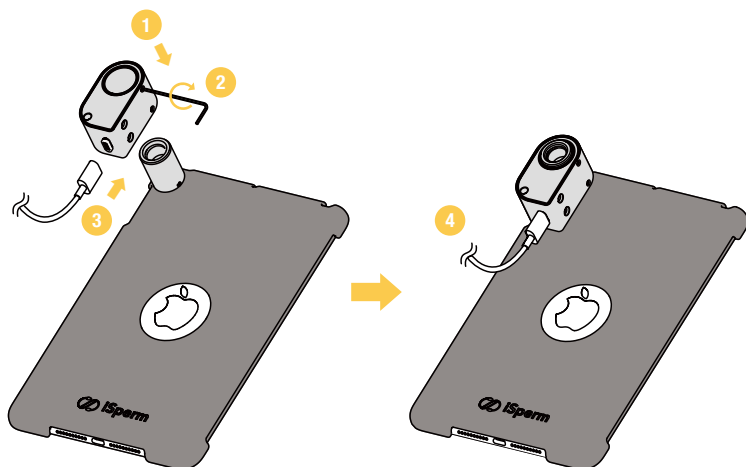

1. Install Heater with the optical lens holder.
2. Use hex wrench to fasten the heater.
3. Connect the power cable to the heater.
4. Connect the power cable to a plug or a power bank.



Once the heater is connected to the power, LED indicator will turn on. When the LED starts flashing, this means that the temperature has reached 37 ± 0.5 °C.

Latex Beads Test – 1/4

Latex Beads Test helps users to obtain more accurate readings with their iSperm. It will help to

- Check if the sampling process is correctly performed.
- Confirm if abnormal hardware problem (sample collector, lens, ...) encounters.

For more information about latex beads, please refer to <https://www.hamiltonthorne.com/index.php/accu-beads>

Preparation for Latex Beads Test

1. Familiarize yourself with the “Sampling > Pipette Method” in this manual to proceed the test.
2. The **recommended concentration** interval for the latex beads solution to be prepared is 10 to 75M/ml, and the size is 4 μm .
3. 46 M/ml is the most ideal concentration for the test. (Refer to the picture on the right)

Calibration by Chamber Type		
	For Fixed Coverslip	For Hemocytometer
#1	35 \pm 5 M/ml	46 \pm 7 M/ml
#2	18 \pm 2.5 M/ml	23 \pm 4 M/ml
#3	3 \pm 1 M/ml	4 \pm 1.5 M/ml

Remind:
Refer to the numbers showing on the column of “For Hemocytometer” to do the comparison.

Instructions for Latex Beads Test

1. Make a sample and count the concentration with “Latex Beads Test” Mode.
2. Count another aliquot of the beads sample with a iSperm Chip. The results should be within 10% of each other to be considered valid.
3. If the results are valid, average the two concentrations and compare with the beads acceptable ranges.
4. Record all results along with pertinent information such as the name of the person performing the procedure.

Latex Beads Test – 2/4

Instructions for Using Latex Beads Test Mode

1. Open iSperm app, and tap “Latex Beads Test”.
2. Check the view is OK, and tap “Start Analysis” to start the test if it's OK.

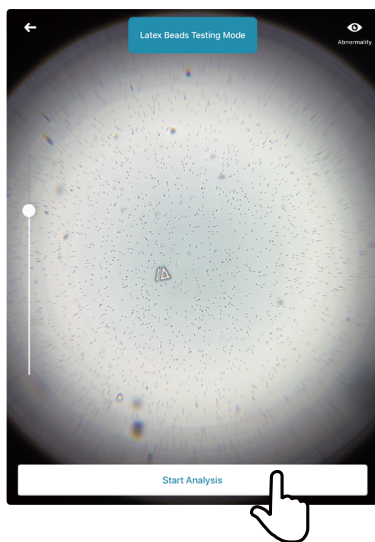
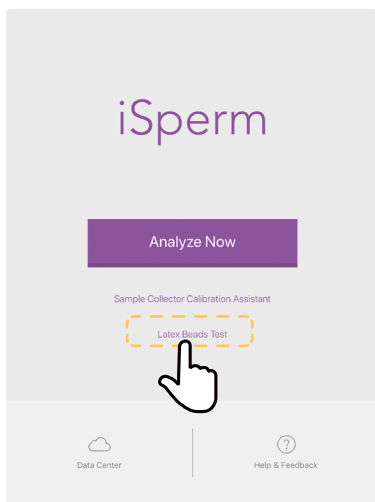

Latex Beads Test – 3/4

- Use 4-view analysis to obtain the averaged reading by rotating the arrow 90° for every measurement ([See 4-view analysis detail in Software > Semen Analysis Section](#)), then tap “Complete Analysis” to finish the tests.

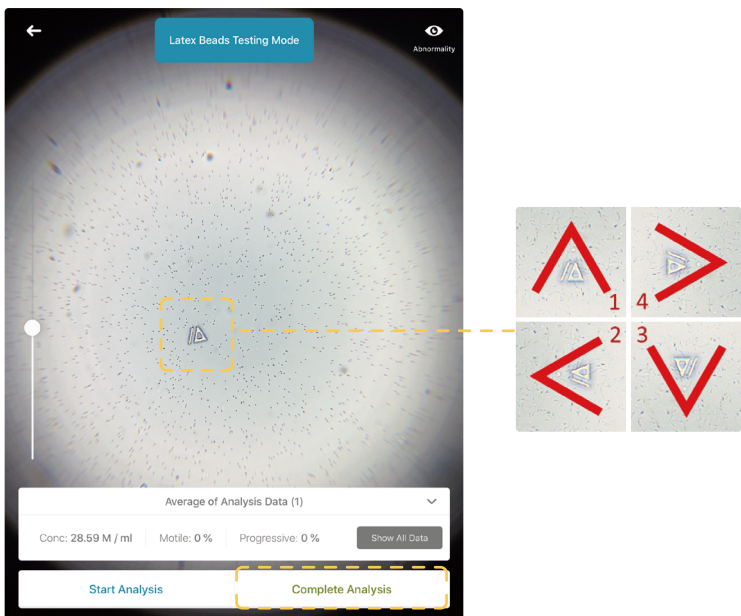

Latex Beads Test – 4/4

- Toggle to see the beads labeled in red, and the average of the four concentrations.

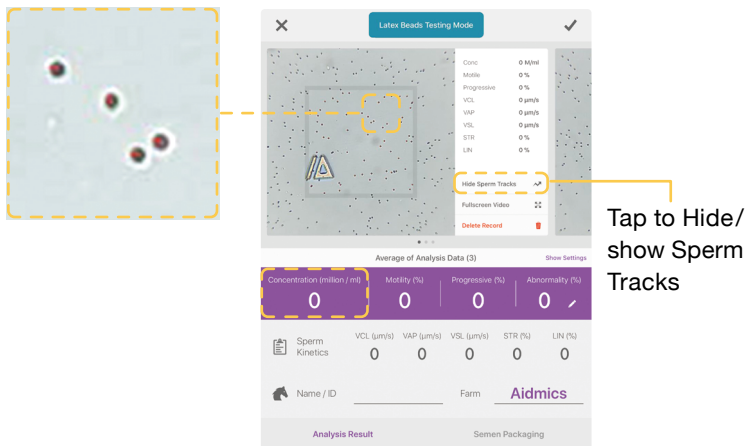

Concentration too high or too low

Follow the Step 4 to see if all the beads are well labeled.

• If well labeled

- Mixing error: Mix latex beads again for even distribution.
- Pipetting error: Reload the chip and to be careful to avoid overloading the chip or underloading the chip.
- Confirm the latex beads concentration using Hemocytometer.
- Contact the distributor if all above issues are checked and the problem still exists.

• If not well labeled

- It may be caused by lens contamination or abnormal light source. Contact the distributor for further assistance.

02

Sampling

Preferred Specimens

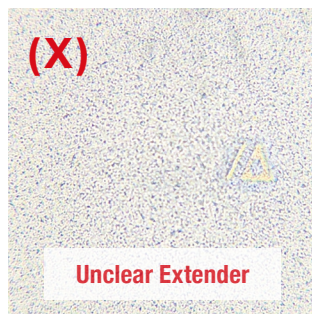
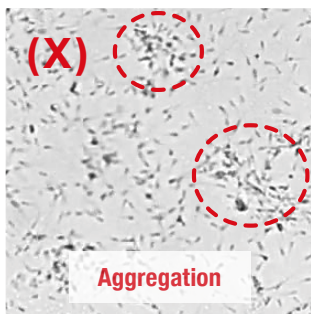
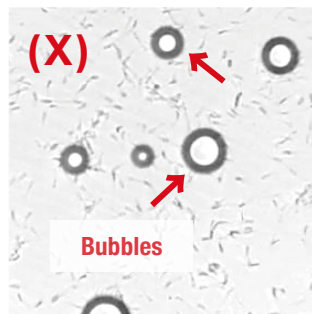
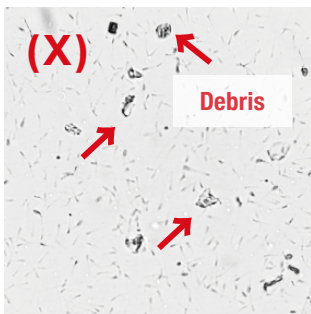
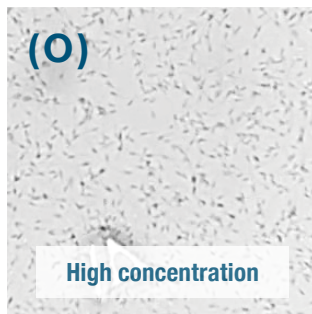
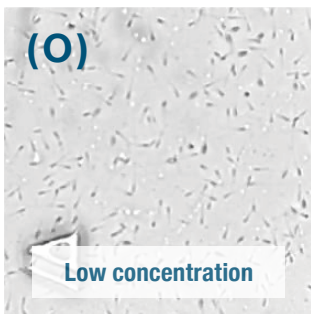

Items in Use



iSperm
(iPad mini/Lens/Heater)



Sample Collector



Stand



Base Chip



Eppendorf



Dropper

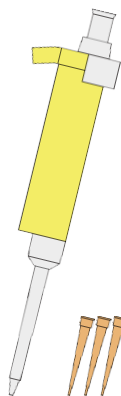

Pipette & Tips

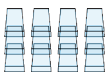

Cover Chip



Measuring Cup

Semen Dilution Principle

Range of analysis:

Parameters	Full Range	Optimized Range
Concentration	10-500 million/ml >500 million/ml for quick preview test only	30-60 million/ml
Motility	0%-100% at concentration between 10 and 500 million/ml	0%-100% at concentration between 30 and 60 million/ml
Progressive Motility	0%-100% at concentration between 10 and 75 million/ml	0%-100% at concentration between 30 and 60 million/ml





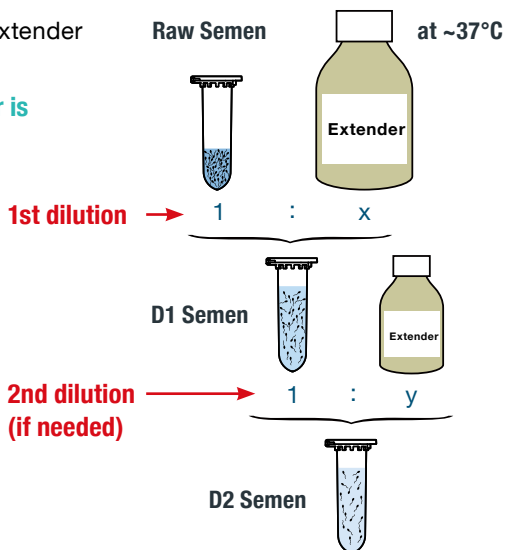

Dilution example:

The ratio of Semen to Extender is on the next page.

Add semen into extender is recommended.



Semen Dilution Principle

	Species	Raw semen	1st dilution Semen : Extender	D1 Semen	2nd dilution Semen : Extender	D2 Semen
	Equine	~30-600M/ml	1 : 2	~10-200M/ml	1 : 3	~2-50M/ml
	Bovine	~0.5-2B/ml	1 : 5	~80-300M/ml	1 : 4	~20-60M/ml
	Caprine	~2-5B/ml	1 : 9	~200-500M/ml	1 : 6	~25-70M/ml
	Canine	~100-500M/ml	1 : 2	~30-165M/ml	1 : 2	~10-55M/ml
	Swine	~200-500M/ml	1 : 1	~100-250M/ml	1 : 4	~20-50M/ml
	Ovine	~2-5B/ml	1 : 9	~200-500M/ml	1 : 6	~25-70M/ml

Preparatory Work

This step is necessary for all sampling methods.

- Use the working board in the iSperm Briefcase, or find a flat, firm/ stable surface (e.g. table).
- Clean the working board/table surface.
- Dusty surface could contaminate “Cover Chip” and hinder the analysis.



working board



firm/stable
Table

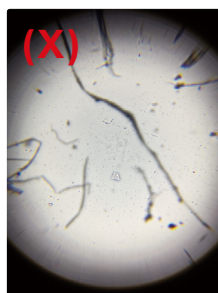

iSperm view of dust/
fiber on the Cover Chip.

- Mount “Base Chip” onto Sample Collector.
- Place “Sample Collector” on the table.

Base Chip ►

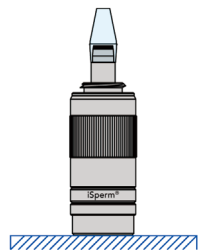

firm and stable table

Three Methods of Sampling

1 Pipette Method

- Sample volume : $7.5\mu\text{L}$.
- Best when the technician is familiar with pipette skills or when limited sperm is available.

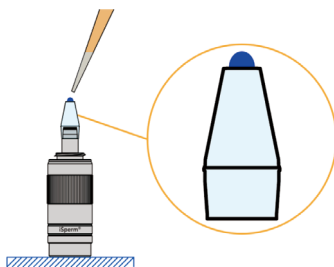

2 Dropper Method

- Sample volume : $\approx 70\mu\text{L}$.
- Best when preferring not to handle pipette and with sufficient sperm.



3 Dipping Method

- For quick preview tests or for fixed sperm.

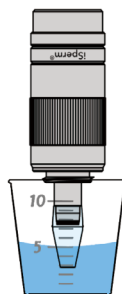

Pipette Method – 1/2

1. Use Pipette to mix the semen gently and thoroughly.
 - **10-15 times** in general to make the semen well-mixed and evenly distributed.
 - **Gentle speed** to prevent bubbles.
2. Drop **7.5µL** onto the Base Chip center area.

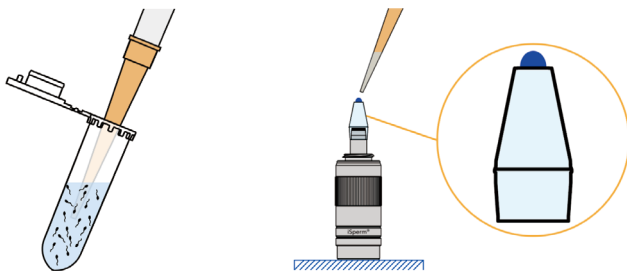

3. Give Sample Collector a gentle knock against the table to spread the droplet.

- **Flat semen droplet is crucial to reduce CV.**

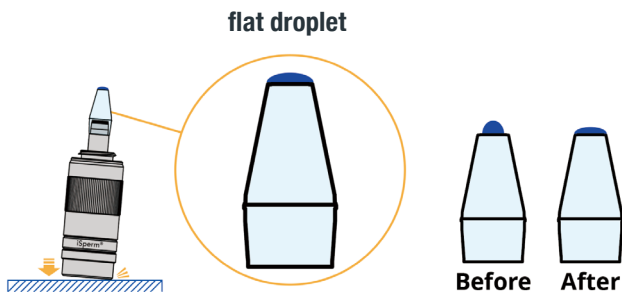

a gentle knock would
do the trick

***Go to next step as soon as possible**

Pipette Method – 2/2

4. Place **“Cover Chip”** on a clean table with open-side facing up.
5. Flip Sample Collector downward.
 - **Droplet will remain on Base Chip.**
6. Press Base Chip into Cover Chip vertically. One will hear a **“click”** first; after that, continue to press down for another 1-2 seconds.

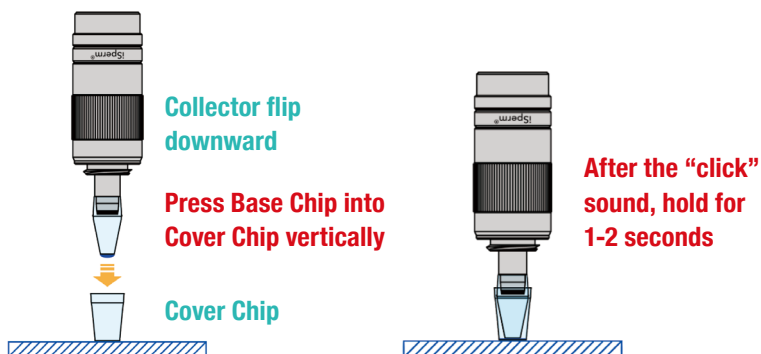

Dropper Method – 1/2

1. Use Dropper to mix the semen gently and thoroughly.

- **10-15 times** in general to make the semen well-mixed and evenly distributed.
- **gentle speed** to prevent bubbles.

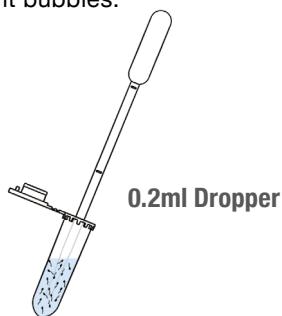

2. Use dropper to inject **70-100 μ L** into Cover Chip.

- About **2mm height** (~100 μ L) in Cover Chip is sufficient.
- **Over 3mm height** (~150 μ L) will lead to spillover when enclosing with Base Chip.

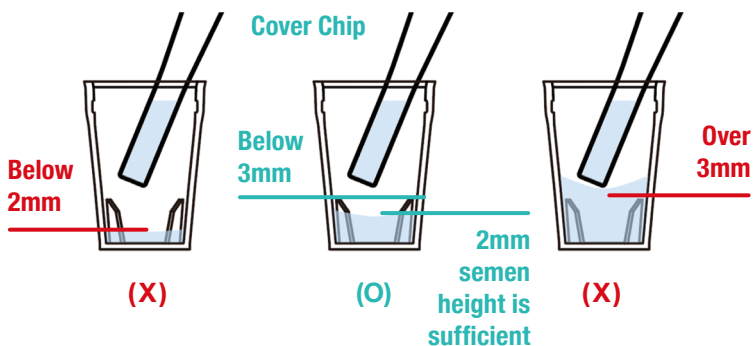

Dropper Method – 2/2

3. Place semen-filled “**Cover Chip**” on a clean table with open-side facing up.
4. Sample Collector Flip downward.
5. Press Base Chip into Cover Chip vertically. One will hear a “click” first; after that, continue to press down for another 1-2 seconds.

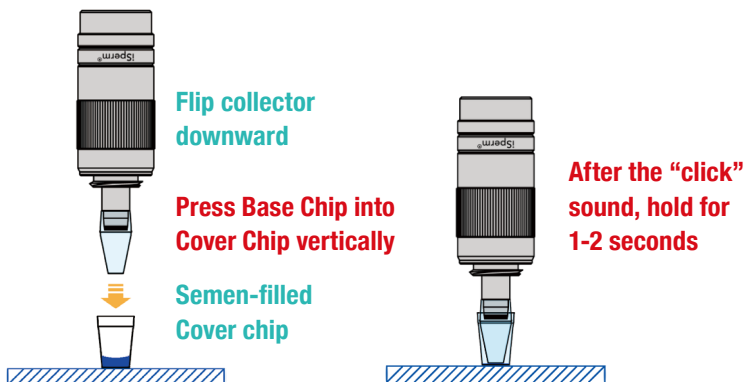

Dipping Method – 1/2

This method is for quick preview tests or fixed semen.

1. Use high volume Dropper/Pipette to mix the semen gently and thoroughly.
2. Wait 30 seconds to let the flow settle.
 - **Fast** microflow causes uncertainty during the dip sampling.

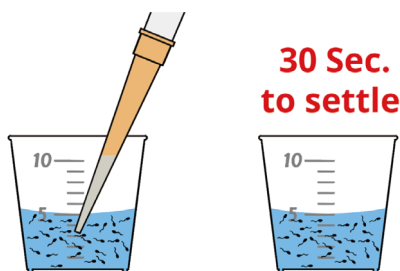

3. Dip Base Chip into semen.

- Immerse Base Chip **5mm below the semen surface**.

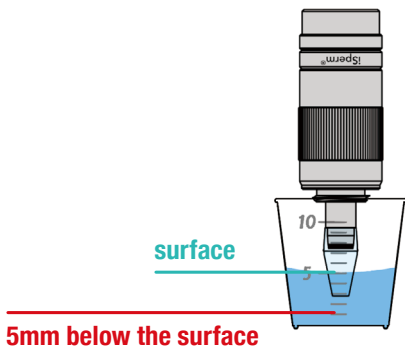

Dipping Method – 2/2

4. Place **“Cover Chip”** on a clean table with open-side facing up.
5. Flip Sample Collector downward; **Droplet will remain on Base Chip.**
6. Press Base Chip into Cover Chip vertically. One will hear a **“click”** first; after that, continue to press down for another 1-2 seconds.

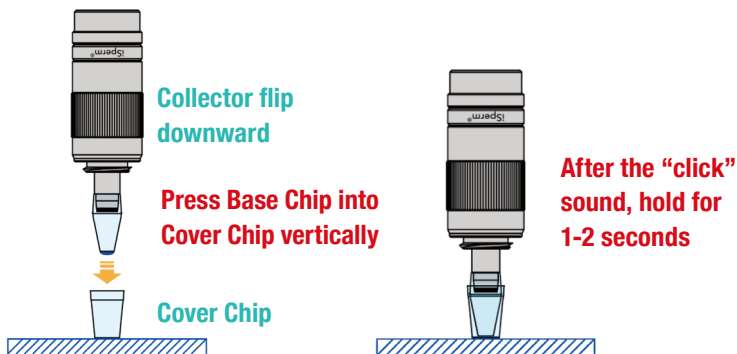

03

Software

Semen Analysis – 1/4

1. Place iPad on a stand.



Do NOT lean Sample Collector against the table

◀ Stand

2. Open iSperm app, and tap “Analyze Now”.

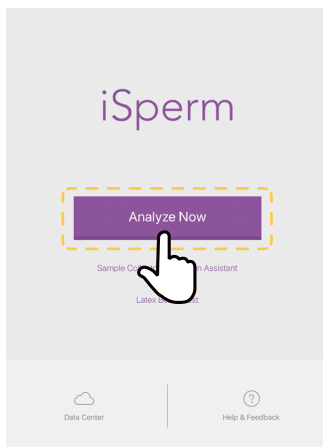

Semen Analysis – 2/4

3. Preview image. (see details in “Preferred Specimens”)

Warning shows up if shake is detected.

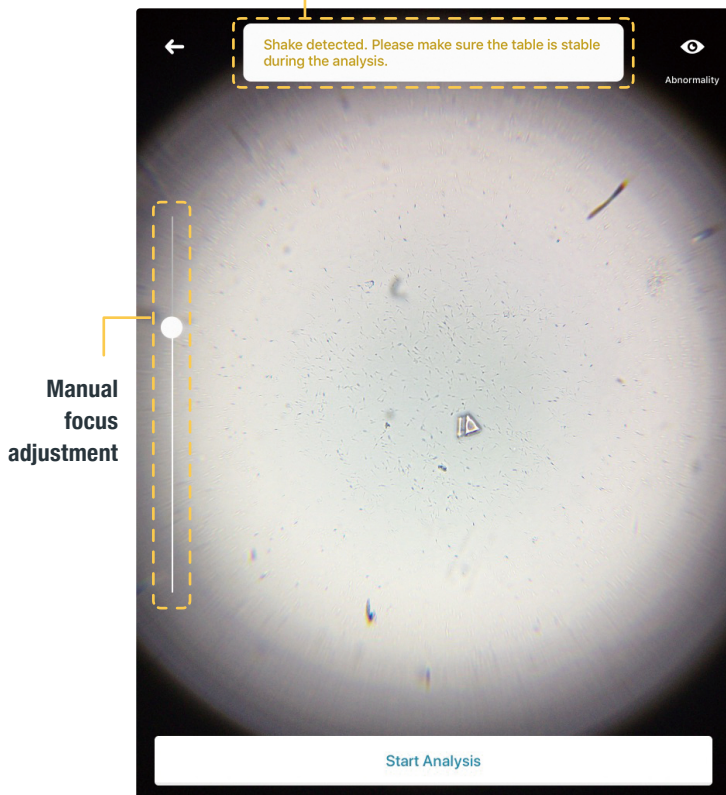

Semen Analysis – 3/4

Multiple-view (typically 4-view) analysis is recommended.

4. Rotate Collector until the logo is pointing up. Tap “Start Analysis”.

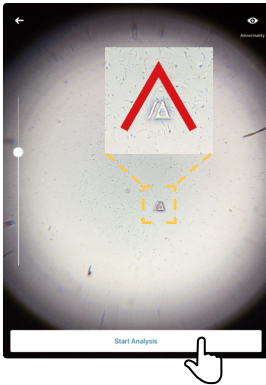

5. Check the analyzed result.



Tap “Show All Data” to view the details.

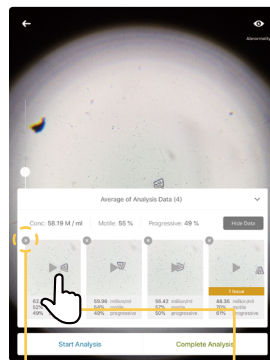

Tap “X” to delete a measurement.

Tap image to view a video

Semen Analysis – 4/4

6. Rotate Collector to complete 4-view analysis. Tap “Start Analysis” for every direction.

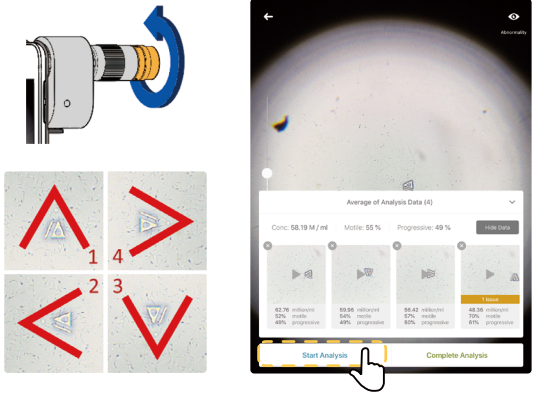

7. Check the “average” of the repeated tests on the screen. Tap “Complete Analysis” to finish and conclude the tests.

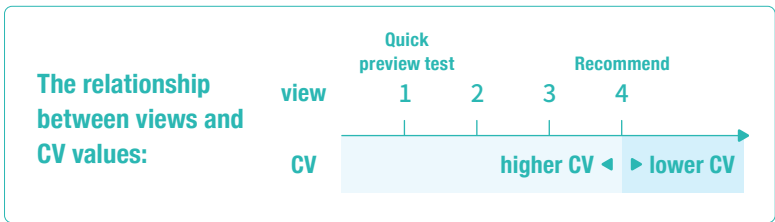
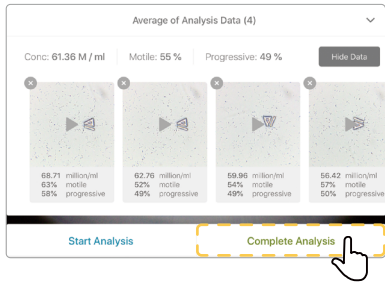

Review Analysis Result

Tap once to stop video.

Tap twice to view fullscreen video.

Slide to view other indices.

Concentration, motility and progressive motility are on the first row.

Enter animal Name/ID.

Tap "Semen Packaging" or slide left to go to the packaging page.

Detailed motility parameters are on the second row.

Concentration (million / ml)	Motility (%)	Progressive (%)	Abnormality (%)
61.36	55	49	0

Motility Parameters	VCL (µm/s)	VAP (µm/s)	VSL (µm/s)	STR (%)	LIN (%)
	83	69	65	94	79

Name / ID: **TEST** Farm: **Aidmics**

Analysis Result | Semen Packaging

Multiple Warnings

- ❗ Severe impurity. Unable to track sperms correctly.
- ⚠ Large bubbles or debris detected.
- ⚠ Shake detected.

Manual Assessment of Abnormal Morphology

During the “Semen Analysis” step, tap the icon to zoom in to check sperm morphology manually.

Follow the steps:

1. Use manual focus bar to adjust the focus.
2. Tap “Pause button” to freeze the image.
3. Fill in the estimated abnormality into the text field.
4. Tap “OK” to leave.

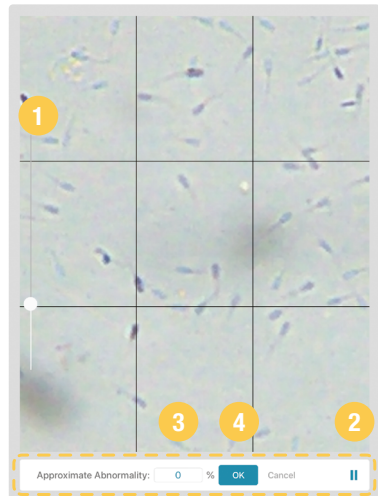
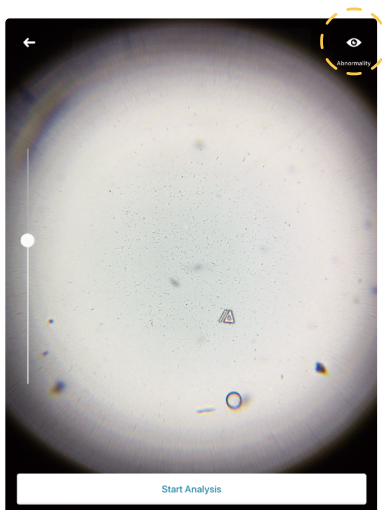



Tap the button on the top left corner to leave without saving the data.

Tap the button on the top right corner to save the result.

Fill in the ratio of semen and extender.

(eg. 1:1 means the semen is diluted in half.)

Choose either Motile or Progressive Sperms for calculation.

Fill in:

1. Total semen volume before packaging.
2. Desired concentration after extention.
3. Volume of each dose.
4. How many motile or progressive sperms should exist in each dose.

When the fields are all filled in, the calculation result will automatically show up below.

Equations for Semen Packaging • Equine



If Total Motile Sperm (billion/dose) is less than Target Number of Sperm Per .Dose, a WARNING message will show up:

“The concentration is too low for packaging. Motile sperm in each dose is less than Target Number of Sperm Per Dose.”

$$\text{Raw Concentration} = \text{Measured Concentration} \times (1+n) \quad [\text{For } 1:n \text{ dilution}]$$

$$\text{Example: } 340.32 \text{ (1)} = 34.03 \text{ (2)} \times (1+9 \text{ (5)})$$

$$\text{Total Sperm} = \text{Raw Concentration} \times \text{Volume}$$

$$\text{Example: } 13.6 \text{ billion (10)} = 340.32 \text{ million (1)} \times 40 \text{ (6)}$$

$$\text{Number of Doses} = \frac{\text{Raw Concentration}}{\text{Desired Extended Concentration}} \times \frac{\text{Volume}}{\text{Volume Per Dose}}$$

***You can choose to round number of doses from settings.**

$$\text{Example: } 11 \text{ (11)} = (340.32 \text{ (1)} / 25 \text{ (7)}) \times 40 \text{ (6)} / 50 \text{ (8)}$$

$$\text{Raw Semen Per Dose} = \frac{\text{Desired Extended Concentration} \times \text{Volume Per Dose}}{\text{Raw Concentration}}$$

$$\text{Example: } 3.7 \text{ (12)} = (25 \text{ (7)} \times 50 \text{ (8)}) / 340.32 \text{ (1)}$$

$$\text{Extender Per Dose} = \text{Volume Per Dose} - \text{Raw Semen Per Dose}$$

$$\text{Example: } 46.3 \text{ (13)} = 50 \text{ (8)} - 3.7 \text{ (12)}$$

$$\text{Total Motile Sperm Per Dose} =$$

$$\text{Raw Concentration} \times \text{Raw Semen Per Dose} \times \text{Total or Progressive Motility}$$

$$\text{Example: } 1.1 \text{ billion (14)} = 340.32 \text{ million (1)} \times 3.7 \text{ (12)} \times 85\% \text{ (3)}$$

Semen Packaging

- Bovine
- Canine
- Caprine
- Swine
- Ovine
- Murine



Tap the button on the top left corner to leave without saving the data.

Tap the button on the top right corner to save the result.

Fill in the ratio of semen and extender.
(eg. 1:1 means the semen is diluted in half.)

Raw Concentration (million / ml)	Measured Concentration (million / ml)	Motility (%)
91.62	45.81	75

Dilution Ratio, Semen : Extender = 1 : 1

Calculate packaging using: Raw Concentration Measured Concentration

Name / ID: **D-0192** Farm: **D-0192**

Parameter	Value	Unit
Total Semen Volume	(1) 1000	ml
Number of Motile Sperms Per Dose	(2) 4000	million / dose
Volume Per Dose	(3) 100	ml

Calculation Result

Number of Sperms (billion)	Extender Volume (ml)	Number of Doses
91.6	700	17

Tap the button to decide which concentration the calculation should use.

(Based on the dilution ratio filled in, there will be two kinds of concentration: the original concentration (before dilution) and the measured concentration.)

Fill in:

1. Total semen volume before packaging.
2. How many motile sperms should exist in each dose.
3. Volume of each dose after packaging.

When the fields are all filled in, the calculation result will automatically show up below.

Equations for Semen Packaging

• Bovine • Caprine • Ovine
• Canine • Swine • Murine



Raw Concentration (million/ml): 91.62
 Measured Concentration (million/ml): 45.81
 Motility (%): 75
 Dilution Ratio, Semen : Extender = 1 : 1
 Calculate packaging using: Raw Concentration | Measured Concentration
 Name / ID: D-0192 | Farm: D-0192
 Total Semen Volume: 1000 ml
 Number of Motile Sperms Per Dose: 4000 million / dose
 Volume Per Dose: 100 ml
 Calculation Result:
 Number of Sperms (billion): 91.6 | Extender Volume (ml): 700 | Number of Doses: 17

Raw Concentration = Measured Concentration \times (1+n) [For 1:n dilution]

Example: 91.62 ¹ = 45.81 ² \times (1+1 ⁴)

Number of Sperms = Raw Concentration \times Total Semen Volume

Example: 91.6 billion ⁹ = 91.62 million ¹ \times 1000 ⁶

Extender Volume =

(Number of Doses \times Volume Per Dose) - Total Semen Volume

Example: 700 ¹⁰ = (17 ¹¹ \times 100 ⁸) - 1000 ⁶

Number of Doses =

Raw Concentration or Measured Concentration \times Total Semen Volume \times Motility

Number of Motile Sperms Per Dose

Example: 17 ¹¹ = (91.62 ¹ \times 1000 ⁶ \times 75% ³) / 4000 ⁷

Data Center - Online Charts

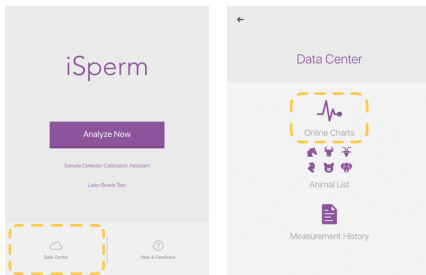

A graph helps you to visualize all the measured history.

Tap to change x Axis.

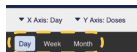

Tap to change y Axis.



Tap to change Sort.

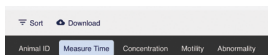

Tap to download Measurement history in Excel format.

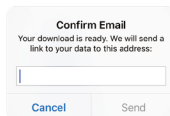

Tap to view the detailed results.

	Concentration	Abnormality	Motility	Motility (Adjusted)
GT	145.38 million/ml	0%	49%	49%
Total Sperm				
48.4 billion	Motile Sperm	23.72 billion	33.94 ml	111 ml
Motile Sperm per Dose				
	Doses	33.2 billion	0	

Data Center - Animal List

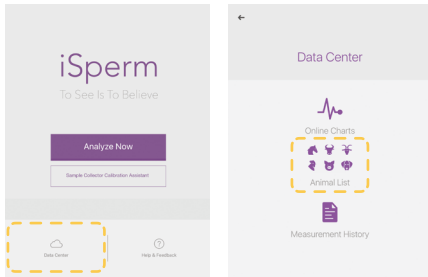

View measurement history of a specific ID.

Tap to change Sort.

Tap Animal ID to view all measurements.

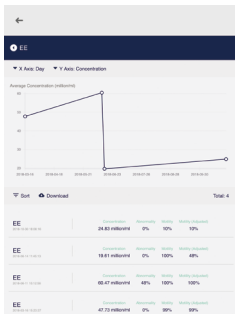

Animal ID	Concentration	Mobility	Abnormality	Measurements
608-2	1836.67 million/ml	48%	0%	1 times
596-3	1354.97 million/ml	0%	0%	1 times
596-2	1348.9 million/ml	0%	0%	1 times
596-1	1169.96 million/ml	0%	0%	1 times
608-1	1018.23 million/ml	60%	0%	1 times
596-4	1012.42 million/ml	5%	0%	1 times
608-3	940.64 million/ml	43%	0%	1 times
512-4	928.51 million/ml	0%	0%	1 times
477-5				

Data shows the average from all measurements.

Data Center - Measurement History

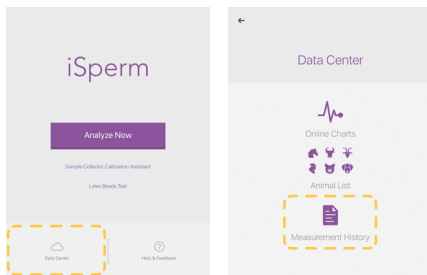

A list of measurement results stored in the local iPad.

Tap any measurement to view detailed results.

- Videos can be viewed if they are stored during the analysis.
- Only the Animal ID and Farm Name can be edited.

Measurement ID	Concentration	Motility	Progressive	Synced	Support
EQ-7 2020/03/11 12:39	0.00 million / ml	0%	0%	Synced	Support
EQ-6 2020/03/11 12:39	0.00 million / ml	0%	0%	Synced	Support
EQ-5 2020/03/11 12:39	0.00 million / ml	0%	0%	Synced	Support
EQ-4 2020/03/11 12:39	0.00 million / ml	0%	0%	Synced	Support
EQ-3 2020/03/11 12:39	0.00 million / ml	0%	0%	Synced	Support
EQ-2 2020/03/11 12:39	0.00 million / ml	0%	0%	Synced	Support
EQ-1 2020/03/11 12:39	0.00 million / ml	0%	0%	Synced	Support

Swipe to the left and tap “Delete” to delete unwanted measurement result.

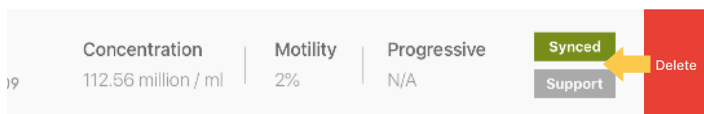

Data Center - Supporting System – 1/4

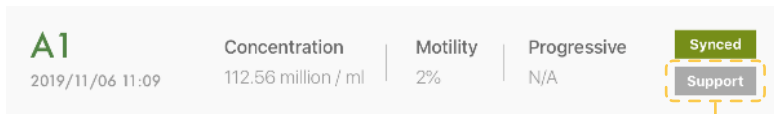

Tap Support to send the data of abnormal measurement via mail directly from iPad. (Should set up the Mail App in advance.)

Set Up the Mail Apps

If you're using Mail App in your iPad, please skip to "Supporting System (3/4)".

1. Please go to "App store" to download "Mail" App.



2. Go to "Settings" and Scroll down the sidebar to find the "Password & Account".

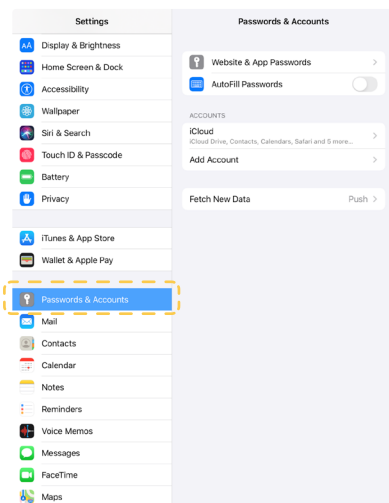

Data Center - Supporting System – 2/4

3. Tap “Add Account” and choose the service that you are familiar with, such as Google or Yahoo.

If this is a shared device, we suggest creating a new account for this device. You may follow the link below to create an iCloud Account:

<https://support.apple.com/guide/icloud/create-an-icloudcom-email-address-mmdd8d1c5c/1.0/icloud/1.0>

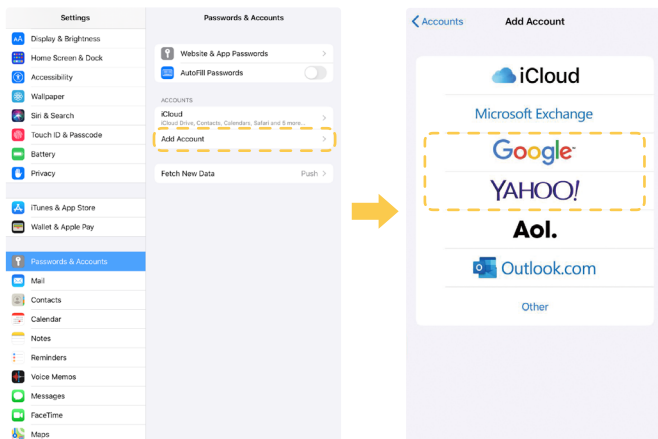

4. After login, please turn on the “Mail” service with this account and click to save.

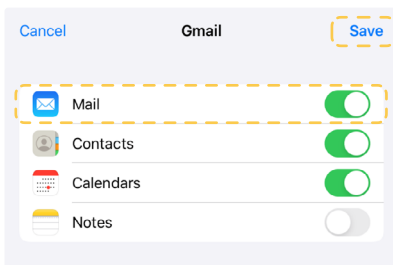

Data Center - Supporting System – 3/4

Find the measurement that you want to report and tap “Support”.
The required data will be appended automatically.

A1 2019/11/06 11:09	Concentration 112.56 million / ml	Motility 2%	Progressive N/A	Synced Support
-------------------------------	--------------------------------------	----------------	--------------------	---------------------------------

Technical Support

If you encountered an issue, it is recommended to contact your local distributor first.

By pressing the “Contact” button, an email editor will be presented with videos and analysis data attached. You can add some more descriptions about the issue. This email will then be sent to iSperm Technical Support Team.

Cancel

Contact

If you see the pop-up on the right, go back to check if the mail sender is ready.

Sender Not Configured

The sender is not configured on this iPad. If you aren't sure how to set up an email address, please refer to iSperm software manual, or contact your local distributor.

OK

Data Center - Supporting System – 4/4

1. Please describe the issue and **DO NOT DELETE** any auto-generated information.
2. Make sure the Internet connection is okay, and tap to send the supporting mails.

- The “Email Sent” will pop up after the mail has been sent.

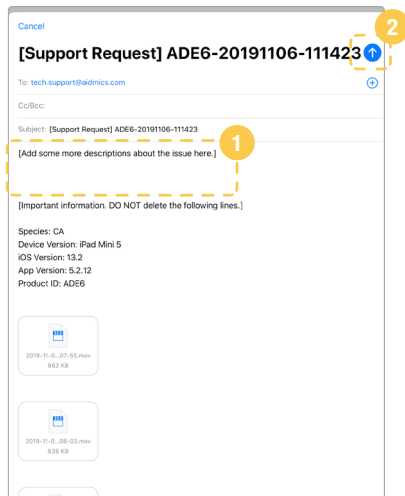
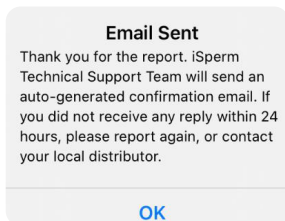

3. After a few minutes, you will receive an auto-generated support request mail in the Mail App. Please wait for further technical support.

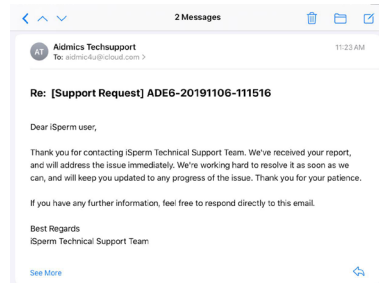

If you didn't see the mail, please check your Internet access and report again, or contact your distributor.

Information/Settings – 1/2

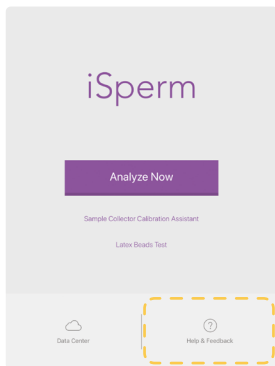

The features of Settings is on the next page.

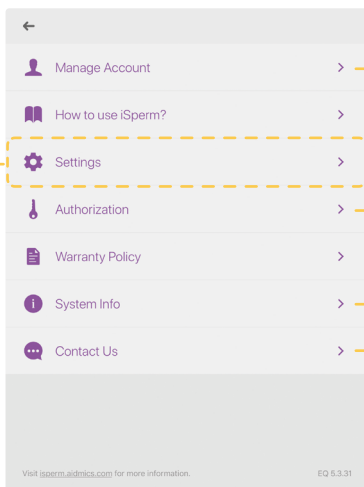

— Login/out iSperm Cloud account.

— Owner info;
Serial Number;

— App & System info.

— Contact info:
Email & Phone.

Information/Settings – 2/2

Customized Settings:

- Round Number of Doses
- Motility Parameters

1. Adjust cutoff values of progressive sperm assessment.
2. Adjust cutoff values of motile sperm assessment.

Round Number of Doses

Should I sperm round number of doses to the nearest integer?

Motility Parameters

Progressive Cutoff Value: STR ≥ 30, VAP ≥ 25
 Motility Cutoff Value: VAP ≥ 20, VSL ≥ 5



Motility Parameters

Progressive Cutoff Value
(Default: VAP ≥ 50, STR ≥ 75%)

1 VAP ≥ 50 μm/s (0-300)

STR ≥ 75 % (0-100)

A sperm matching these conditions will be labeled progressive.

Motile Cutoff Value
(Default: VAP ≥ 20, VSL ≥ 0)

2 VAP ≥ 20 μm/s (0-50)

VSL ≥ 0 μm/s (0-20)

Sperms matching these conditions will be labeled motile, and will be included in the calculation of the average VCL, VAP, VSL, STR and LIN.

Definitions

Definitions



VCL Curvilinear Velocity (μm/s)
 VAP Average Path Velocity (μm/s)
 VSL Straight Line Velocity (μm/s)
 STR Straightness (VSL/VAP)
 LIN Linearity (VSL/VCL)

VCL
(Curvilinear velocity) =

The summation of distance between the sperm head positions in each frame

Elapsed time

VAP
(Average path velocity) =

The averaged path determined by smoothing the position of head

Elapsed time

VSL
(Straight line velocity) =

Distance between the first and last points

Elapsed time

STR (Straightness) =

VSL/VAP in percent(%)
is a measure of track compactness.

LIN (Linearity) =

VSL/VCL in percent(%)
is a measure of track direction.

04

Data Backup

- **iSperm Cloud**

iSperm Cloud allows users to view measurement history using web browsers (Chrome, Safari, etc.) at desktop computers, laptops, and cellular phones.

- **iCloud**

iSperm App supports a full backup for iPad on iCloud.

All the videos and data in iSperm App can be restored if you need to use a new iPad.

iSperm Cloud – 1/2

1. Login iSperm account at <https://ispermcloud.aidmics.com/>

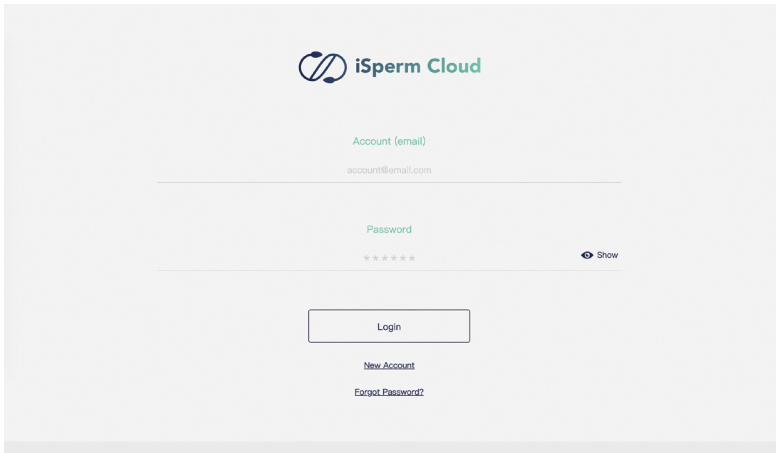

The image shows the login page for iSperm Cloud. At the top center is the iSperm Cloud logo, which consists of a stylized 'S' icon followed by the text 'iSperm Cloud'. Below the logo are two input fields. The first is labeled 'Account (email)' and contains the text 'account@email.com'. The second is labeled 'Password' and contains six asterisks. To the right of the password field is a 'Show' button with an eye icon. Below the input fields is a 'Login' button. Underneath the 'Login' button are two links: 'New Account' and 'Forgot Password?'. The background is a light gray gradient.

2. Choose animal species.

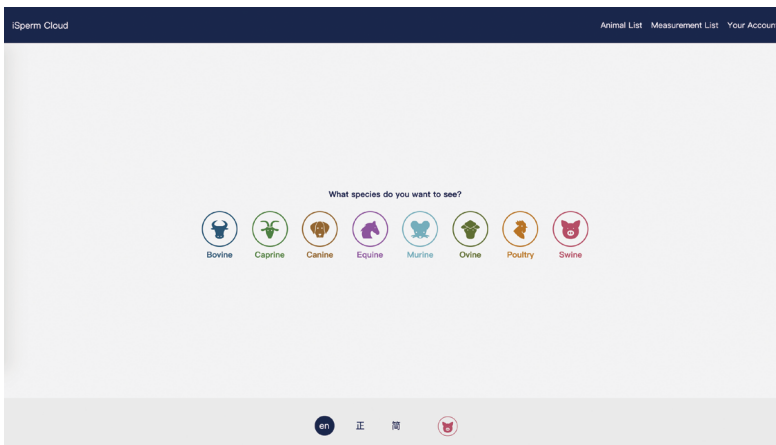

The image shows the species selection page in the iSperm Cloud application. At the top, there is a dark blue header with 'iSperm Cloud' on the left and 'Animal List Measurement List Your Account' on the right. Below the header is a large white area with the text 'What species do you want to see?' centered. Underneath this text are eight circular icons, each with a different animal and a corresponding label below it: Bovine (blue bull), Caprine (green goat), Canine (orange dog), Equine (purple horse), Marine (light blue whale), Ovine (green sheep), Poultry (orange chicken), and Swine (red pig). At the bottom of the page, there is a footer with a language selector showing 'en', a navigation bar with '正' and '開' buttons, and a small red circular icon.

3. All the functions and user interface on the “Data Center” are almost identical to iSperm App.



iCloud Backup – 1/2

Before backup, be sure that you have enough space available in iCloud.

When you sign up to iCloud, you will get 5GB of iCloud storage for free. If you need more iCloud storage, you can buy more from your iPad with your Apple ID. Learn more about prices in your region: <https://support.apple.com/kb/ht201238>

1. Connect your device to a Wi-Fi network.
2. Go to Settings > [your name], and tap iCloud.
3. Tap iCloud Backup.
4. Tap Back Up Now. Stay connected to your Wi-Fi network until the process completes.

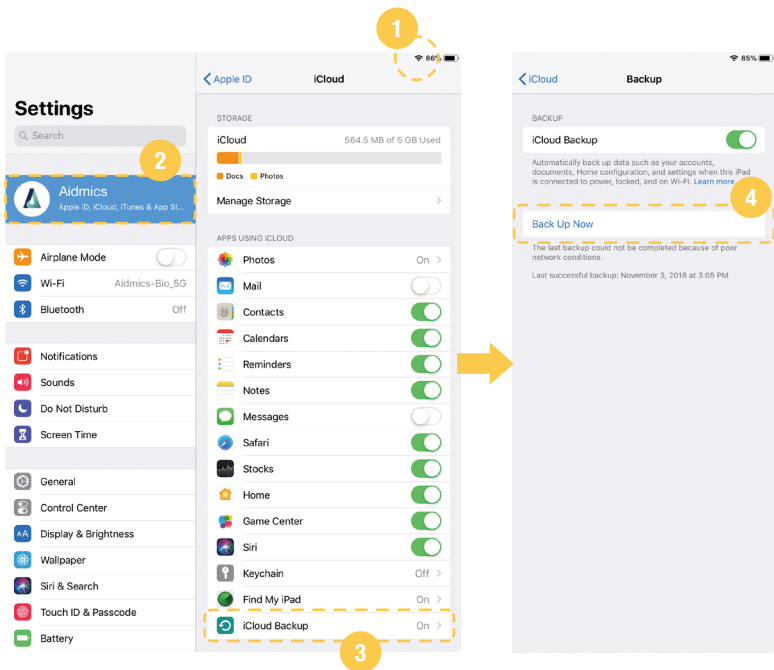

iCloud Backup – 2/2

Check the status of iCloud backup

You can check the progress and confirm if the backup is completed. Go to Settings > [your name] > iCloud > iCloud Backup. Under Back Up Now, you'll see the date and time of your last backup.

Automatically back up with iCloud Backup

To let iCloud automatically back up your device each day, here's what you need to do:

- Make sure that iCloud Backup is turned on in Settings > [your name] > iCloud > iCloud Backup.
- Connect your device to a power source.
- Connect your device to a Wi-Fi network.
- Make sure that your device screen is locked.

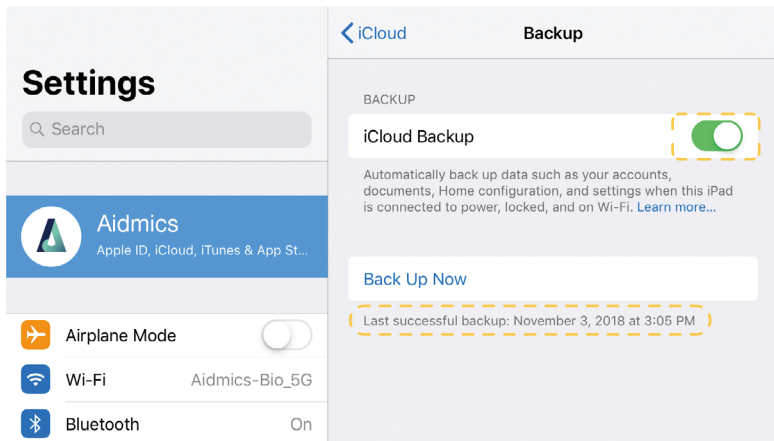

05

Data Transfer

- **Export Videos to Photo App**

Videos taken on iSperm app can be exported to Photos App. Each video would come with its respective reading set (concentration, motility, ...) shown underneath the video.

- **Transfer Data from iPad**

You can copy videos and measurements between your computer and apps on your iOS device using File Sharing.

Export Videos to Photo App – 1/4

1. Go to Measurement History. Tap the Video Export Button to enter “Video Selecting” Mode.

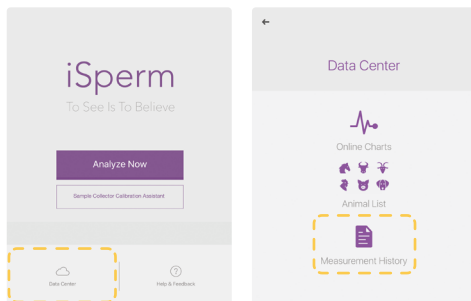

The screenshot shows a list of test results. Each row represents a test with the following columns: Test ID, Date/Time, Concentration, Motility, Progressive, and Synced/Support buttons. A dashed yellow box highlights the 'Video Export' icon (a square with a right-pointing arrow) in the top right corner of the screen.

Test ID	Date/Time	Concentration	Motility	Progressive	Synced	Support
EQ-7	2020/03/11 12:39	0.00 million / ml	0%	0%	Synced	Support
EQ-6	2020/03/11 12:39	0.00 million / ml	0%	0%	Synced	Support
EQ-5	2020/03/11 12:39	0.00 million / ml	0%	0%	Synced	Support
EQ-4	2020/03/11 12:39	0.00 million / ml	0%	0%	Synced	Support
EQ-3	2020/03/11 12:39	0.00 million / ml	0%	0%	Synced	Support
EQ-2	2020/03/11 12:39	0.00 million / ml	0%	0%	Synced	Support
EQ-1	2020/03/11 12:39	0.00 million / ml	0%	0%	Synced	Support

Video Export

Export Videos to Photo App – 2/4

2. Select the measurements you want to output.
3. Check the box at the bottom if tracks are needed.
(To see the difference, please refer to “Export Videos to Photo App - 4/4”)
4. Tap the button on the top right corner to export.

The screenshot shows a mobile application interface for selecting and exporting videos. The title bar is purple with a close button (X) on the left and a checkmark on the right. Below the title bar, there are two video entries, each with a dashed yellow selection box around its radio button. The first entry is EQ-7, dated 2020/03/11 13:27, with a concentration of 210.83 million / ml, 100% motility, and N/A progressive sperm. The second entry is EQ-6, dated 2020/03/11 12:39, with a concentration of 0.00 million / ml, 0% motility, and 0% progressive sperm. At the bottom of the screen, there is a checkbox labeled 'Export Sperm Tracks' which is checked. A yellow arrow points from the selection boxes of the two video entries down to the 'Export Sperm Tracks' checkbox. A yellow circle with the number 4 is next to the checkmark in the top right corner of the title bar.

Video ID	Time	Concentration	Motility	Progressive
EQ-7	2020/03/11 13:27	210.83 million / ml	100%	N/A
EQ-6	2020/03/11 12:39	0.00 million / ml	0%	0%

Export Sperm Tracks

Export Videos to Photo App – 3/4

5. Await until all videos are exported.

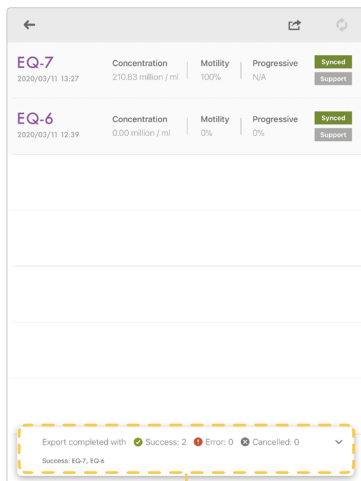
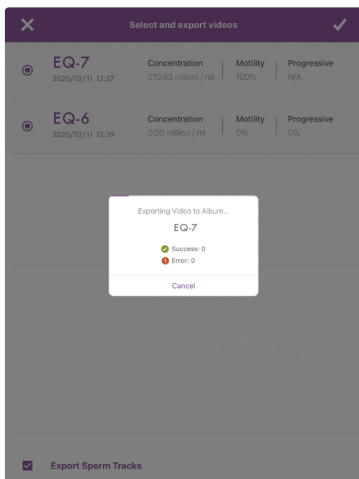

Export result

6. Go to Photos App on your device and tap Albums.

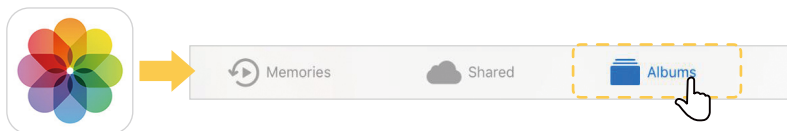

Export Videos to Photo App – 4/4

7. Tap the iSperm's Album and find the videos to play.

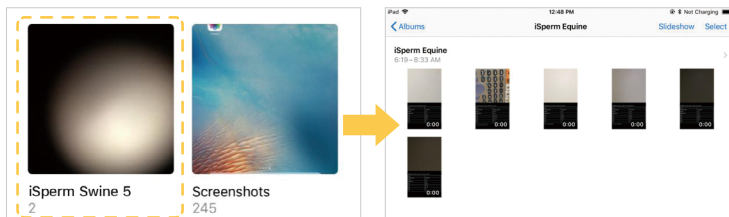

Videos exported with/without Sperm Tracks

Export Sperm Tracks

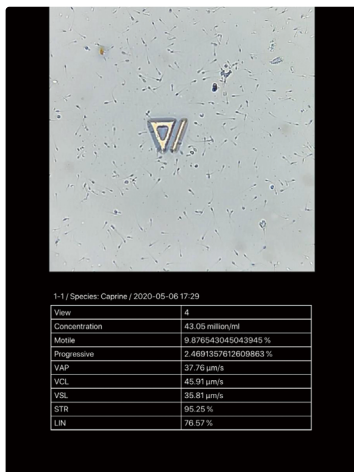

Export Sperm Tracks

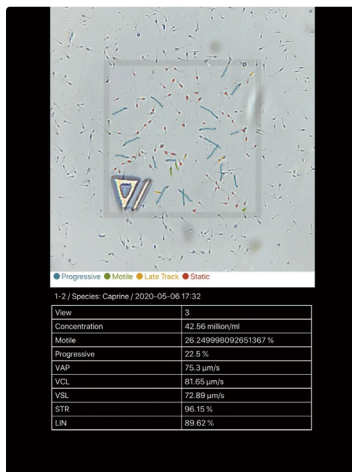

Transfer Data from iPad (iTunes) – 1/3

Please refer to the “Transfer Data From iPad (Finder)” if your computer is MacOS Catalina or later.

1. Open iTunes on your Mac or PC.
2. Connect your iPad to your computer using the USB cable that comes with your device. You might see a prompt on the iOS device asking you to Trust This Computer. Tap Trust to continue.

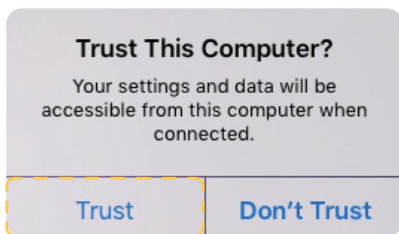

3. Click your device on iTunes.

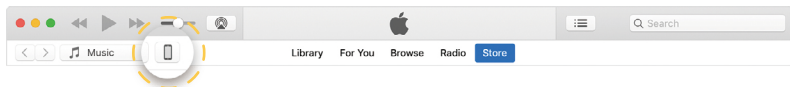

Transfer Data from iPad (iTunes) – 2/3

4. In the left sidebar, click File Sharing.
5. Select iSperm App. Videos are stored in folders for each measurement. The format of the folder name is **"Name + Species + Date"**. You can save the videos to your Mac or PC.

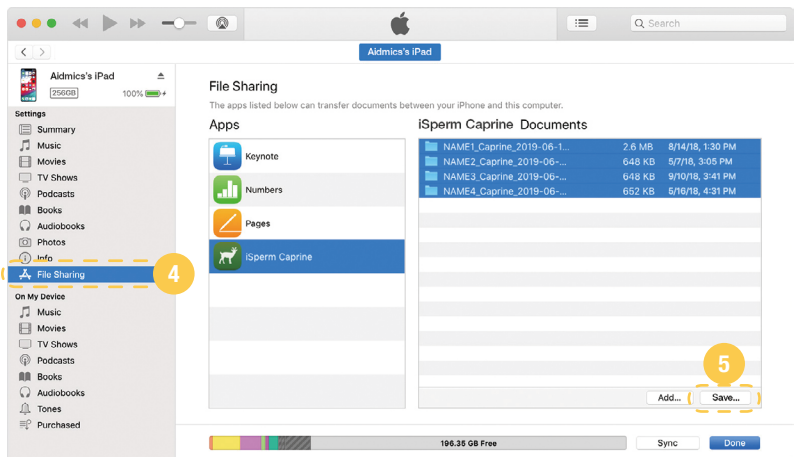

Transfer Data from iPad (iTunes) – 3/3

6. When opening the folder from your Mac or PC, you will see multiple videos (depending on how many views you analyzed) and a “tsv” file which summarizes all the measurements.

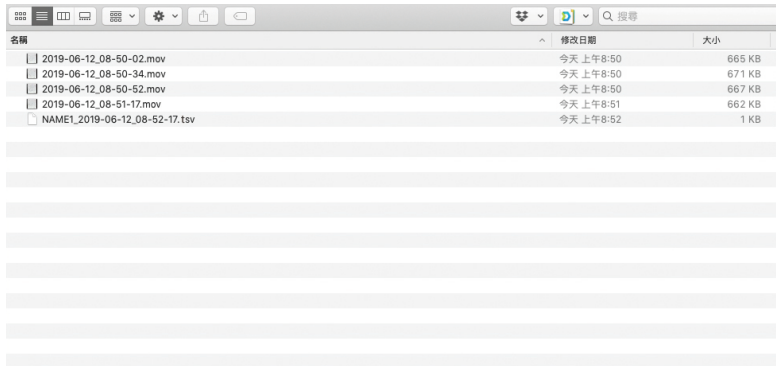

Experiment	Name	Program's Count	Males' Count	Gender	Time															
NAME1		839 +/- 70.8, VGL +/- 80	WIP +/- 20.8, VSL +/- 0	N/A	2019-06-12 08:52:17															
ID	Concentration (Inches/Sec)	Males (%)	Progression (%)	WIP (m/s)	VGL (m/s)	VSL (m/s)	LSR (%)	SFR (%)	Abnormal Traffic Detected	Shale Detected	Sublime / Large Debris Detected	Impurity								
1	239.63	95	87	118.43	238.32	38.42	83.9	46.59	NO	YES	NO	Detected								
2	248.6	95	91	79.51	149.86	43.52	88.89	45.42	NO	YES	NO	Detected								
3	187.87	94	11	88.88	138.32	34.78	85.42	48.98	NO	YES	NO	Detected								
4	84.76	95	4	83.71	182.72	71.88	84.24	48.38	NO	YES	NO	Detected								
Median	238.29	94	22	82.22	188.79	47.88	82.2	45.3												
Packaging																				
Number of Stems	Estimate Volume (mL)	Number of Spores (Billions)	Total Volume (mL)	Number of Male Spores per Stem (Inches/Volume)	Volume per Stem (mL)	Dilution Ratio														
N/A	N/A	N/A	N/A	N/A	N/A	1:10														
Other Settings																				
Adjustment History (%)																				
0	94																			

Transfer Data from iPad (Finder) – 1/2

Please refer to the “Transfer Data From iPad (iTunes)” if your computer is PC or MacOS Mojave or earlier.

1. Connect your iPad to your computer using the USB cable that comes with your device. Also make sure that your MacOS Catalina is updated to the newest version.
2. Enter “Finder”, find your iPad in the left sidebar and click.

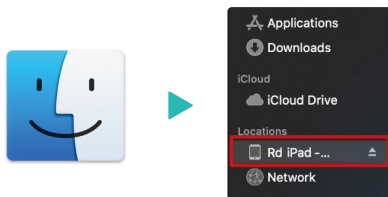

3. Click the “Trust” button to connect your iPad mini.

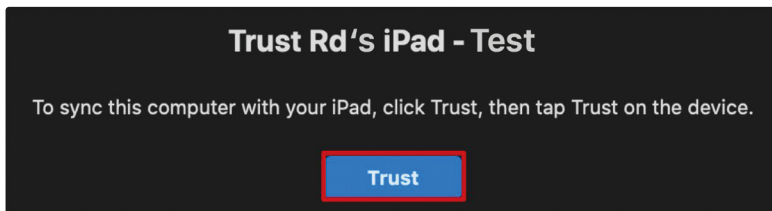

4. You might see a prompt on the iOS device asking you to Trust This Computer. Press Trust to continue.

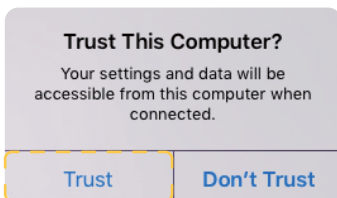

Transfer Data from iPad (Finder) – 2/2

5. Click the “Files” label on above.

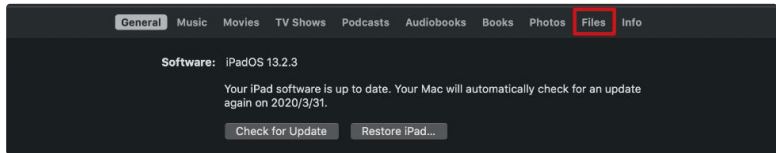

6. Find iSperm app on the application list, and select all the files under the application.

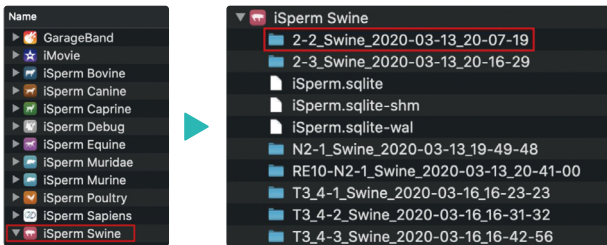

7. Drag the files into the target folder.

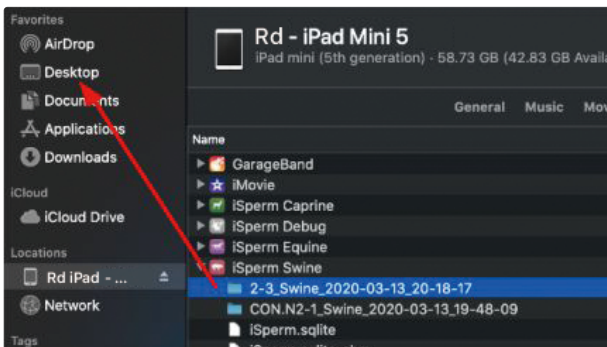

06

Frequently Asked Questions (FAQ)

Can all types of frozen semen be analyzed?

Generally there are three types of frozen semen.

Frozen sample with **unclear** extender **CANNOT** be analyzed by iSperm.

**Optically clear
extender**

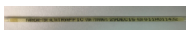

USA 11HO11432

**Unclear
extender**



USA 1JE576

**Sex-sorted
semen**



USA 511HO11314

iSperm

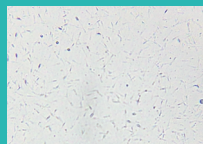
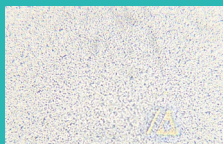
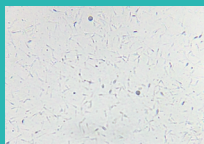

Microscope

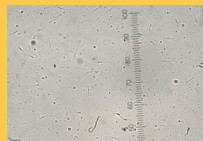
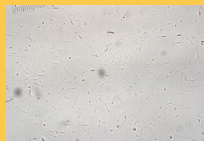

CASA

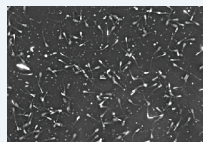
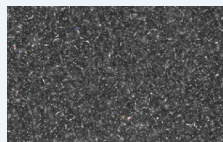
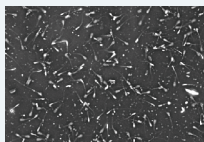

(O)

(X)

(O)

If Cover Chip is contaminated...

- If Cover Chip is contaminated, it is okay to use tissue paper to gently wipe the cover surface clean.
- It is recommended to keep the table surface, Base Chips, and Cover Chips clean.

Microscopic view of dust/fiber on the Cover Chip.

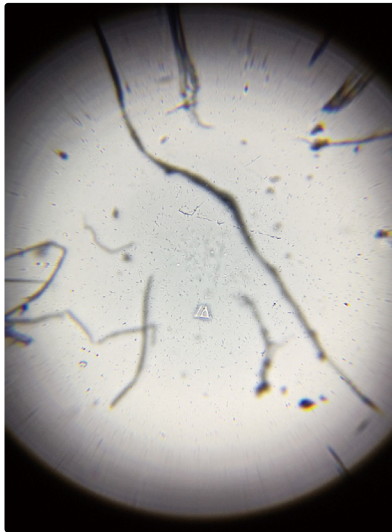

If bubbles are visible...

- **Re-sampling** is required if bubbles are visible. (See the picture below, Bubbles hinder the analysis significantly.)
- Bubble trapping is usually associated with mixing process.
- Mix the semen gently can prevent from forming bubbles. (It may take some practice to be skilled at bubble-free mixing.)

Microscopic view of bubbles.

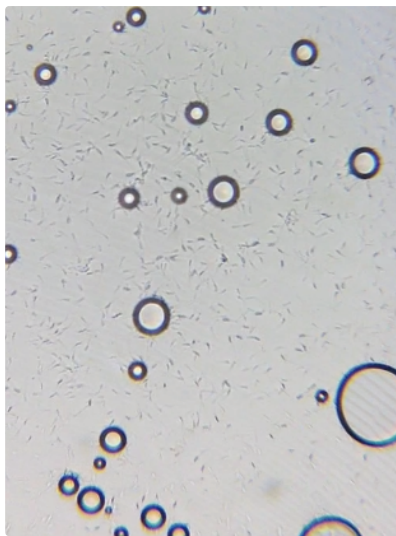

If image is blurry...

- Check if Base Chip and Collector are intact and locked correctly.
- Check if Sample Collector is locked correctly.
- Check if Cover Chip is clean.
- If image is blurry in every chip, the lens may have been contaminated.
Please contact your distributor for technical service.

Microscopic view of blurry image.

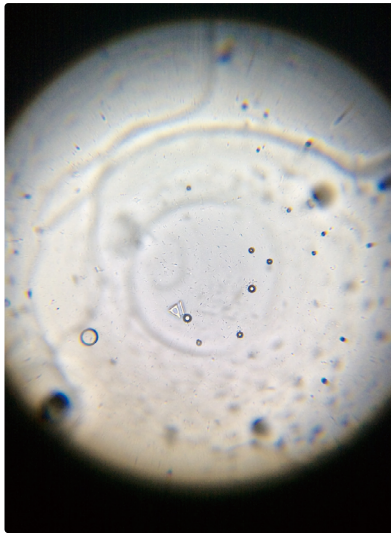

If sperms aren't distinguishable

Possibilities:

- Sample could be too concentrated, and further dilution is required.
- Base Chip & Cover Chip aren't locked correctly to enclose a thin layer. It leads to multi-layers of sperm cells instead of a thin layer. In this case, re-sampling is required.

Single layer (O)

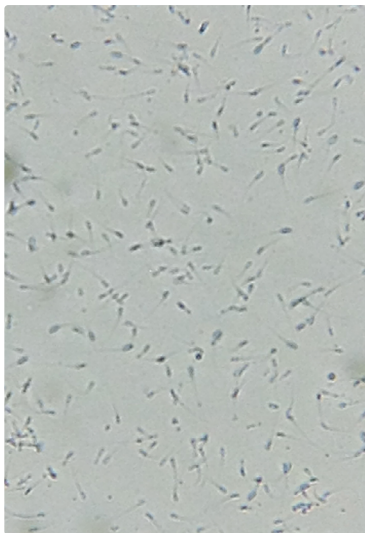

Multiple layers (X)

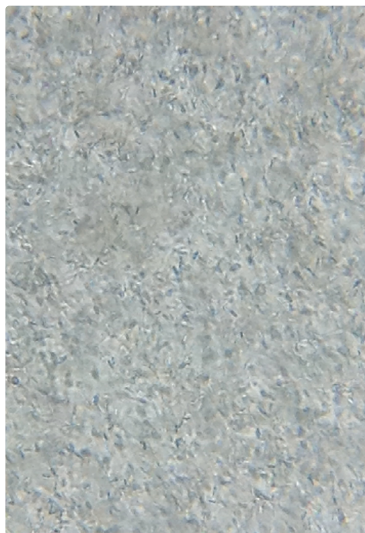

Causes of Variation

Possibilities:

- Mix Semen Uniformly

It is critical to make sure the sperm cells are distributed uniformly. See below examples of non-uniform semen. Further mixing is required.

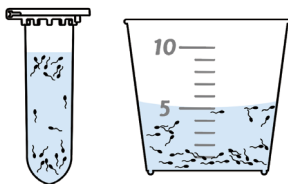

Mix semen thoroughly before Every sampling.

- Time gap (delay) on Cover-Base Lock-in

It is important to **lock the Base Chip to the Cover Chip as soon as the sample is attached**. Experiments show that deviation exists with 10-second time gap.

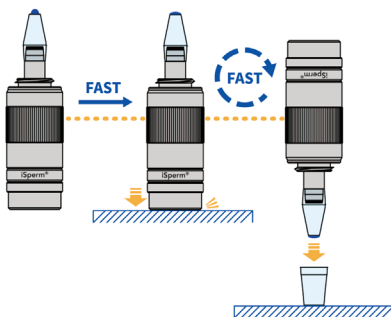

After semen is attached, complete the sampling as soon as possible.

07

Validation



Concentration Validation: iSperm vs. Nucleocounter & Hemocytometer

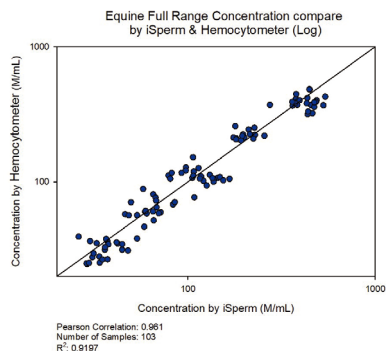
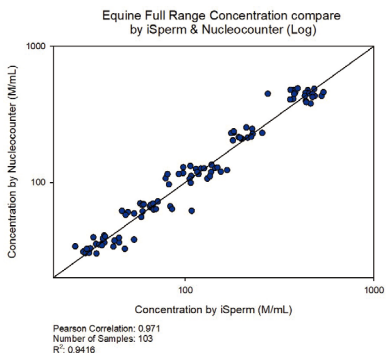

Motility Validation: iSperm vs. CASA

The motility is compared at concentration of 20-60M/ml.

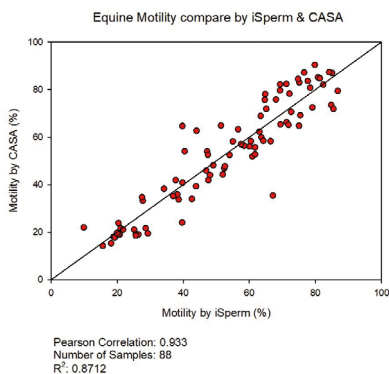



Concentration Validation: iSperm vs. Hemocytometer & CASA

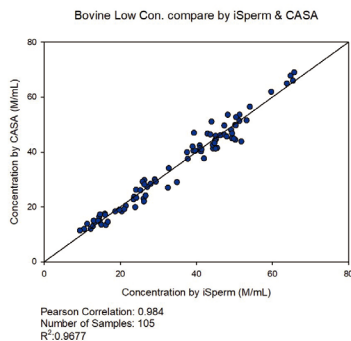
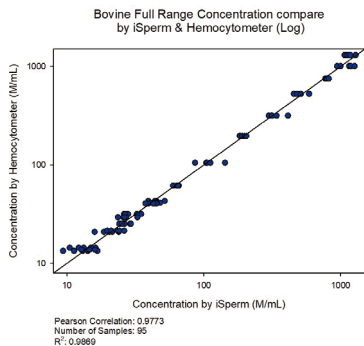

Motility Validation: iSperm vs. CASA

The motility is compared at concentration of 20-60M/ml.

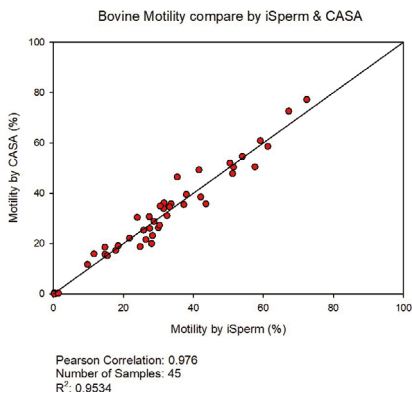



Concentration Validation: iSperm vs. CASA

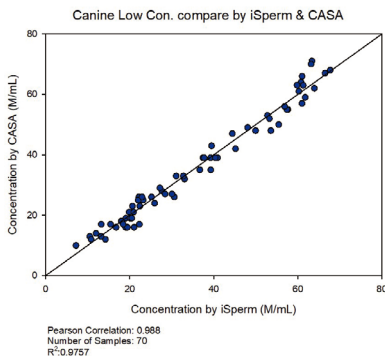

Motility Validation: iSperm vs. CASA

The motility is compared at concentraton of 20-60M/ml.

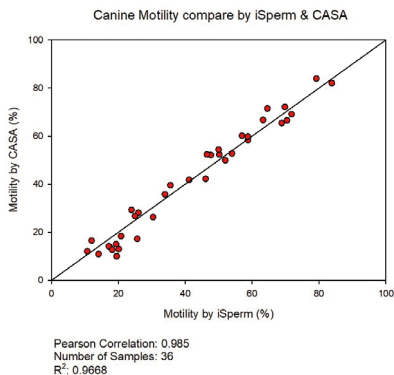



Concentration Validation: iSperm vs. Hemocytometer & CASA

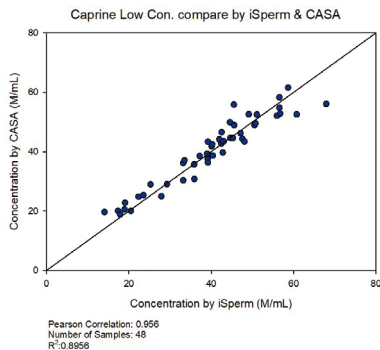
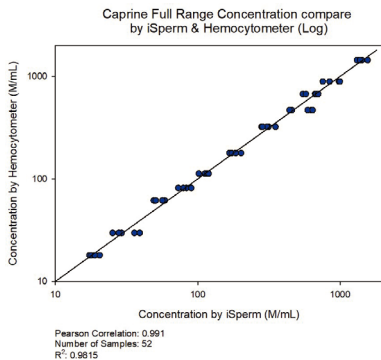

Motility Validation: iSperm vs. CASA

The motility is compared at concentration of 20-60M/ml.

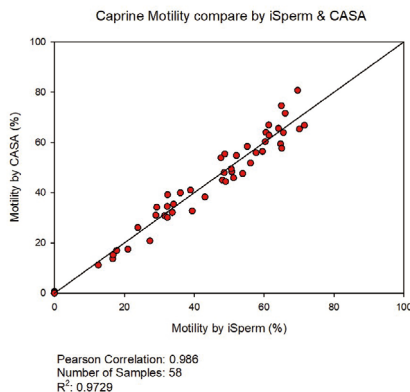



Concentration Validation: iSperm vs. Hemocytometer & CASA

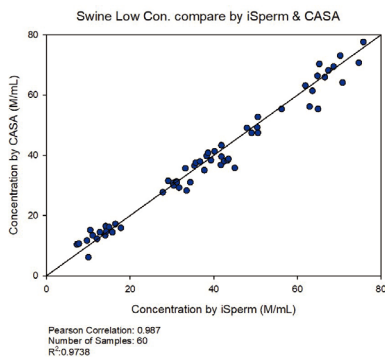
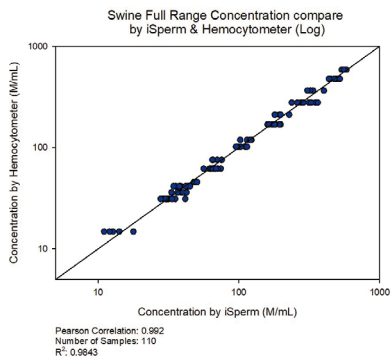

Motility Validation: iSperm vs. CASA

The motility is compared at concentration of 20-60M/ml.

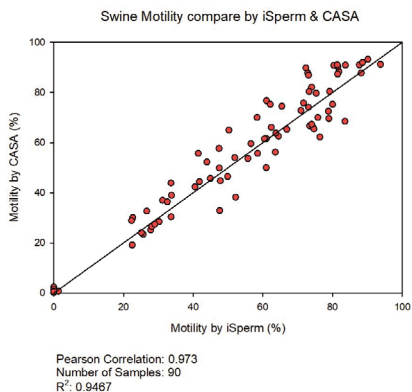

08

Certificates

Certificate of Compliance

No. 0L160311.AB0558

Technical Construction File no. AID-2016001-A1



Certificate's
Holder:

Aidmics Biotechnology Co., Ltd.
Rm. 1, 11F., No.171, Sec. 3, Roosevelt Rd., Da'an
Dist., Taipei City 106, Taiwan (R.O.C.)

Certification ECM
Mark:



Product:
Model(s):

Sperm Analyzer
ADBISP

Verification to:

Standard:
EN 61000-6-2:2005/AC:2005,
EN 61000-6-4:2007/A1:2011,
EN 61000-4-2:2009, EN 61000-4-3:2010,
EN 61000-4-8:2010

related to CE Directive(s):
2014/30/EU (Electromagnetic Compatibility)

Remark: The product(s) has been verified on a voluntary basis. The product(s) satisfies the requirements of the Certification Mark of ECM, in reference to the above listed Standard(s). The above Compliance Mark can be affixed on the product(s) accordingly to the ECM regulation about its release and its use. The regulation can be found at www.entecerma.it. This Certificate of Compliance can be checked for validity at www.entecerma.it

This verification doesn't imply assessment of the production of the product(s).

Additional information, clarification about the **CE** Marking:

We attest that a TCF for the **CE** Marking process is in place. Whereas the Manufacturer is Responsible to start the **CE Marking Certification Procedure** and to perform all the necessary activities, as required by the Directive before placing the **CE** Mark on the product(s).



Date of issue 11 March 2016

Chief Manager
Tim Mahon



Expiry date 10 March 2021

Deputy Manager
Viola Miller



Ente Certificazione Macchine Srl

Via Ca' Bella, 243 – Loc. Castello di Serravalle – 40053 Valsamoggia (BO) - ITALY
☎ +39 051 6705141 📠 +39 051 6705156 ✉ info@entecerma.it 🌐 www.entecerma.it

CERTIFICATION

Applicant : Aidmics Biotechnology Co., Ltd.
Address : Rm.1, 11F., No.171, Sec.3, Roosevelt Rd., Da'an Dist., Taipei City 106, Taiwan (R.O.C.)
Manufacturer : Aidmics Biotechnology Co., Ltd.
Address : Rm.1, 11F., No.171, Sec.3, Roosevelt Rd., Da'an Dist., Taipei City 106, Taiwan (R.O.C.)
Description of EUT : Sperm Analyzer
Trade Name : N/A
Model Number : ADBISP
Product Series : N/A
Type of Test : FCC Part 15 Subpart B
Technical Standard : **Emission**
 FCC Part 15 : Subpart B Class A
 CISPR 22 : 2008 Class A
Report Number : HA160126-FD
Receipt Date : 24-FEB-2016
Issue Date : 08-MAR-2016
Test Result : **Compliance**

The above equipment was tested by *HongAn TECHNOLOGY CO., LTD.*, for compliance with the requirement set forth in the FCC Rules and Regulation Part 15, Subpart B and the measurement procedures were based on ANSI C63.4.

Note :

1. The results of the test report relate only to the sample tested.
2. The test report shall not be reproduced without the written approval of *HongAn TECHNOLOGY CO., LTD.*

Approved by:

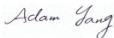

Adam Yang / Section Manager



HongAn TECHNOLOGY CO., LTD.

NO.15-1, CWEISHUH KENG, CWEIPIN VILLAGE,
LINKOU DIST, NEW TAIPEI CITY, TAIWAN, R.O.C.

TEL : +886-2-26030362

FAX : +886-2-26019259

E-mail : haflab@ms19.hinet.net

BSMI Registration No. : SL2-IN-E-0023, SL2-IS-E-0023,
SL2-A1-E-0023, SL2-R1-E-0023,
SL2-R2-E-0023, SL2-L1-E-0023

FCC Designation No. : TW1071, TW1163

TAF Accreditation No. : 1163

VCCI Registration No. : R-2156, C-2329, T-219, G-696



Note

Note



Note



Aidmics Biotechnology

www.aidmics.com
service@aidmics.com